

OWNER'S MANUAL

POWER WHEELCHAIR

N5909

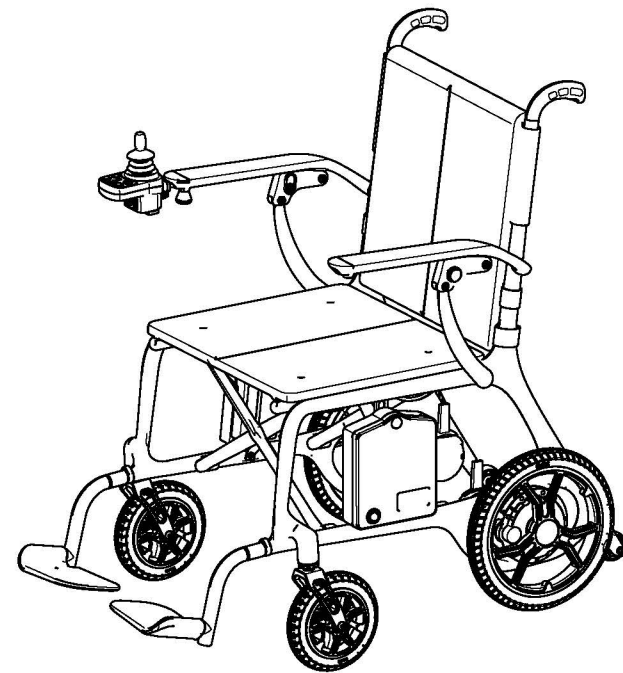

| | |
|---|-------|
| 1. Instruction..... | 2 |
| 2. precautions for safe use..... | 3-10 |
| 3. Structure and Performance..... | 11-12 |
| 4. Specification..... | 13 |
| 5. Installation, Folding and Debugging..... | 14-15 |
| 6. Use and Operation..... | 16-20 |
| 7. Fault Diagnosis and Troubleshooting..... | 20 |
| 8. Safety Devices and Accident Treatment..... | 21 |
| 9. Maintenance..... | 21-23 |
| 10. Transportation and Storage..... | 24 |
| 11. Opening and Checking | 24 |
| 12. Warranty..... | 25 |

1. Instruction

Read and follow all instructions, warnings, and notes in this manual before attempting to operate your power wheelchair for the first time. If there is any information in this manual which you do not understand, or if you require additional assistance for assembly or operation, please contact with your authorized local provider. These symbols below in this manual are used to identify warnings and important information. All of them are very important to your safety. It is strongly recommended that you should read and understand them completely.



WARNING! Failure to heed the warnings in the manual may result in personal injury.



ATTENTION! Failure to heed the cautions in the manual may result in damage to the power wheelchair.

1.1 This power wheelchair integrates advanced technology with modern style. Especially, its structure for quick dis-assembly and assembly are very convenient for you to store or place at the trunk of your vehicle while traveling. We are certain that the design features, excellent performance and trouble -free operation of this product will ensure your daily life more convenient.

1.2 This power wheelchair is suitable for all the disabled persons, the elderly and the infirm who have difficulty in walking. The maximum user weight is 100kg.

1.3 This power wheelchair is of an indoor type. It is of Model N5909. Here, "N" indicates an indoor power wheelchair, "5" is the code of category of products, "909" is the serial number of this type.

1.4 This power wheelchair is an indoor type, and suitable for an indoor use and the flat streets near buildings, but not for the grass, gravel, or larger slope and motorized roads, rainy and snowy days, either.

2. Precautions for Safe Use

 **Warning!** To ensure your safety, please read and understand this manual. You must be on high alert when driving any vehicle to ensure safety.

 **Warning!** Please read the following warning carefully to avoid damage or personal injury caused by improper operation. Wheelchair users should take appropriate safety measures and obey local pedestrian traffic rules. The company are not responsible for personal injury and/or product damage caused by improper operation. When you sit in the wheelchair, it may be difficult for others to see you. Use of safety equipment such as reflectors, reflective clothing, lights and safety signs is critical to your safety.

 **Warning!** Please consult your health care professional regularly to ensure that there are no health or physical conditions that limit or compromise your safe operation of the wheelchair. If you are taking prescription or over-the-counter medications, or if physical activity is limited, please consult your physician. Some medications and medical conditions may impair your ability to operate the wheelchair.

 **Warning!** Do not operate your wheelchair while drunk. Drinking may affect your safe operation of the wheelchair.
Warning! All wheelchairs are not the same. Please take time to learn before driving.
Warning! Be able to operate a wheelchair safely needs time and practice.

 **Warning!** Please do not use the wheelchair for other purposes, applications such as weight training, sports and athletics, traction, moving or dragging may cause safety hazards and excessive stress in wheelchairs.
Warning! This wheelchair is for one person only, the maximum load weight as 135kg with no passengers allowed. Do not carry anything to avoid overloading and possible rollover.

 **Warning!** We strongly recommend that you do not smoke in the wheelchair. If you decide to smoke in the wheelchair, please abide by the following safety rules: keep ash at a safe distance from the wheelchair seat. Make sure your cigarette is extinguished completely when you throw it away.

 **Warning!** Before getting on/off the wheelchair, you should sit back as far as possible to avoid injury caused by overturning.
Warning! The arm rests are not transfer bars, do not use them transfer out of the chair as this may cause damage to the product or injury to yourself.
Warning! Avoid concentrating your weight on the footrest. Otherwise, it will cause overturning and personal injury.

Warning! Do not use the wheelchair in manual mode without accompanying person, which could cause personal injury.
Warning! When sitting in the wheelchair, please do not move by yourself, which will cause personal injury. Ask your accompanying person for help if necessary.
 **Warning!** Do not make any alterations to the wheelchair without permission. Adding accessories may change some of the wheelchair specifications such as total weight, size, or center of gravity. Please note that some changes may damage things around you.
Warning! Please do not change your seat specification. Do not place any cushions or pillows on the seat, which could result in the user falling out from the wheelchair caused by instability of seat.

 **Warning!** Be extremely careful when using oxygen near electrical circuits or combustible materials. Please contact your oxygen supplier for information on the safe use of oxygen.

 **Attention!** Do not change the controller Settings. Please ask your service provider to check the controller Settings every 6-12 months. If you notice any changes in your ability to control the wheelchair, please contact your service provider.



Warning! During the operation, the wheelchair may suddenly stop at any time. Do not operate the wheelchair if it is abnormal or irregular.



Warning! To prevent the wheelchair from losing control and moving on its own, do not place the wheelchair in manual mode on any inclined plane.



Warning! If you expect to sit in a fixed position for a long time, turn off the power to prevent accidental movement of the wheelchair.



Warning! Avoid any accessories that may interfere with the operation of the joystick. Otherwise, it will cause the wheelchair to move unexpectedly.



Warning! Keep yourself, clothing and other objects away from the wheel while the wheelchair is moving. Do not drag anything behind the wheelchair while driving. Loose clothing and other items can get sucked into tires and/or turning gears.



Attention! Do not connect any other devices to the electronic system or turn on any other devices with the wheelchair battery.
Attention! When disconnecting wiring harness, please hold the terminal in case damage to it. Do not pull the wiring harness directly.



Warning! Keep all charger connector terminals clean and dry, away from damp sources to prevent damage to electrical system and/or personal injury.



Attention! The storage temperature of wheelchair is -15°C~40°C. Long-term storage in low or high temperature environment will damage its function.



Attention! Always check electrical components for corrosion. Check all brakes for looseness, wear or damage. Check wiring harnesses and terminal posts for breakage. If necessary, please contact your service provider.



Attention! Please ensure the safety of wheelchairs and batteries during transportation. Never transport wheelchairs or batteries with combustible materials.



Attention! Please use the battery under the supervision of service technicians authorized by the company. Battery connectors, terminals and related accessories contains lead and lead components to contains lithium, lead and lead components



Attention! Do not connect the cable directly to the battery terminal/clip for charging.
Attention! Do not remove the fuse from the battery harness. If the fuse is damaged, please contact your supplier for replacement.



Warning! Do not operate the wheelchair with dead battery. You might get trapped.
WARNING! Please slow down when turning, do not make sharp turns. Keep the center of gravity stable when turning. To prevent rollover, do not move the center of gravity in the opposite direction when turning.



WARNING! Drive straight up the slope when climbing; both front wheels should land at the same time. To reduce the possibility of overturning, do not make an angle with the slope; do not make the wheel on one side or the side of the wheelchair to go up the slope first. Be particularly careful when climbing any slopes.



WARNING! Do not drive on potentially dangerous roads or slopes, including but not limited to roads covered with snow, ice, cut grass, or wet leaves.



WARNING!Keep the wheelchair moving when climbing. If you need to stop, restart slowly and speed up carefully.



WARNING! Please drive down a slope at the minimum speed. If the descent speed is faster than expected, release the joystick lever to stop the wheelchair, and then press the lever lightly to control the descent speed.



WARNING!The recommended maximum climbing angle (see parameter table) was tested in a controlled environment. Your wheelchair's ability to climb is affected by factors such as your weight, the speed of your wheelchair, and the angle at which you approach the slope.



WARNING!Reversing is only possible on flat roads. When reversing, please operate smoothly at low speed. Please stop frequently and check to make sure there are no obstacles on the road. To prevent rollover, do not tilt down or backward along the slope.



WARNING!When sitting in a wheelchair, avoid any position or movement that can change your center of gravity. This may cause the wheelchair to tilt.



WARNING! Do not put all the weight on one side of the wheelchair deck, such use may cause the wheelchair to tilt.

WARNING!Do not put your hands above the seat or tilt your body. This may damage the backrest and cause you to fall down.



WARNING! Even if your wheelchair can cross high obstacles, we recommend that you do not try to cross a height exceeding 25mm. Such operations may cause the wheelchair to be unstable. Riding a wheelchair over an obstacle of such height can cause a rollover and severe personal injury. If you have any concerns about safely crossing obstacles, please ask for help. Please pay **ATTENTION** to your operating skills and personal restrictions. You may need to remove or cover the sills and install ramps at exits and entrances.



WARNING! Do not attempt to climb over obstacles on slopes.
WARNING!Do not rely on a wheel to get over obstacles.



WARNING!Never operate the wheelchair near railroad tracks or crossings.



WARNING! Do not drive the wheelchair along the edge of a stream, lake or sea. Please do not drive the wheelchair across the water.



WARNING!Do not expose wheelchair to open flames.



ATTENTION! Keep your wheelchair in a dry and clean environment. Don't take the wheelchair to shower, bath, pool or sauna. Rain, snow, salt, fog / spray conditions and frozen / smooth surfaces can cause wheelchair screws and some fixtures to rust untimely.



ATTENTION! Avoid prolonged exposure to excessively hot and cold environments; it may damage the cushioned and non-cushioned parts of the wheelchair as well as the battery and battery components.



ATTENTION! Do not drag the wheelchair. Dragging may exceed its own speed threshold, causing damage to key parts of the wheelchair.



ATTENTION! Be extremely careful when moving an idle wheelchair up and down the stairs. The wheelchair must be folded, requiring the participation of several physically capable people.



WARNING! Do not cross stairs or escalators with the wheelchair.



WARNING! Do not sit on a wheelchair while it is in any transport vehicles.



WARNING! For safer handling: Always keep the power off before moving. Failure to do so may result in touching the joystick and causing the wheelchair to move unexpectedly. Make sure the brakes are locked so to prevent the wheelchair from moving during handling. This wheelchair could be driven into the elevator, while you must turn off the power and sit firmly to ensure that the wheelchair will not move after entering the elevator.



WARNING! Do not place the wheelchair on the front seat of the vehicle during transportation, it may move and disturb the driver.



ATTENTION! Please contact your service provider if any spare parts on the seating system are loose. Replace worn or damaged padding immediately.



WARNING! Radio wave sources, such as radio stations, television stations, amateur radio transmissions, two-way radios and mobile phones can affect wheelchair control.

The following WARNINGS should reduce the possibility of severe injury due to accidental braking or movement of the power wheelchair:

1. Do not turn on portable personal communication devices, such as citizen band (CB) radios and mobile phones when the power wheelchair is powered on;
2. Pay attention to nearby transmitters, such as radio or television stations, and try to avoid approaching them.
3. In the event of unexpected movement or brake release, the power wheelchair should be turned off as soon as possible under safe conditions;
4. Please note that adding accessories or parts, or modifying power wheelchairs may make it more susceptible to interference from radio wave sources (note: there is no easy way to assess the influences of above modifications on the wheelchair's overall immunity from radio wave sources); and report to the power wheelchair manufacturer of all accidents of unexpected movement or brake release, and pay attention to nearby radio sources and other important information.

3. STRUCTURE AND PERFORMANCE

3.1 Structure of the Power Wheelchair

This power wheelchair consists of the main part including the front wheel, drive wheel, frame, controller, motor with mechanism, armrest, push handle, backrest, seat base, footrest, battery case and charger, the structure shown in Figure 1.

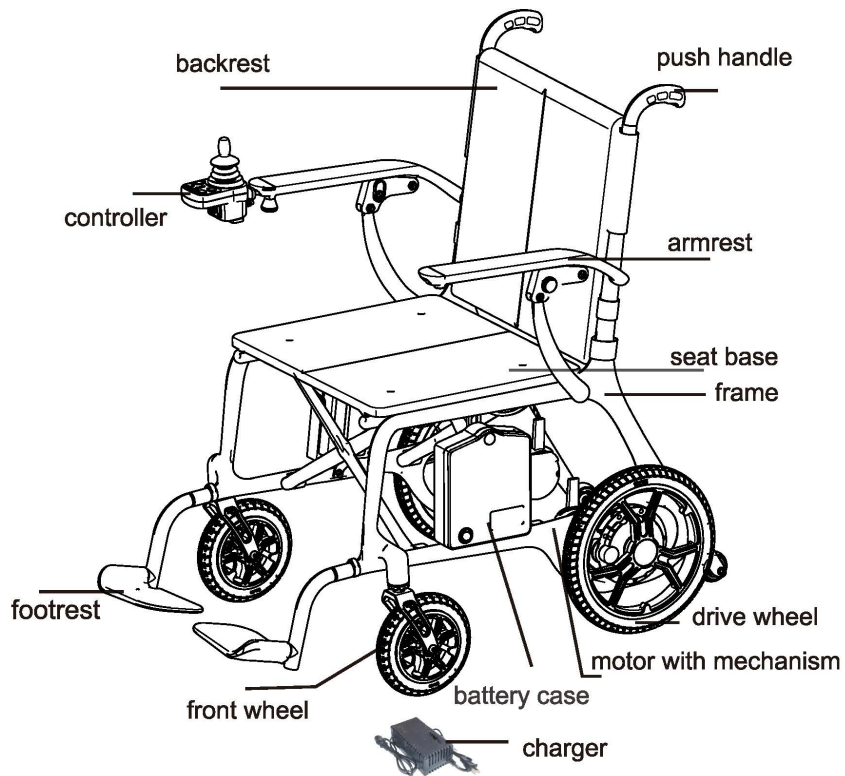
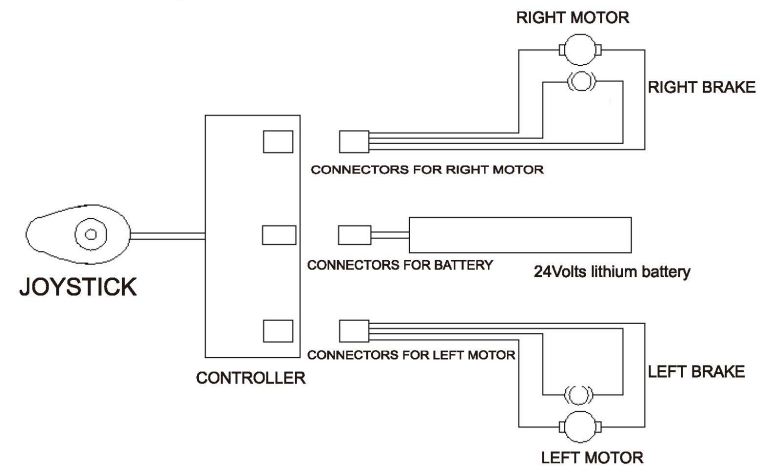

fig. 1

3.2 Product characteristics of the power wheelchair

- Classification by anti-shock type: wheelchair is internal power supply;
- Classification according to the degree of anti-shock: wheelchair belongs to the B-type application part;
- Classification according to the degree of protection of the feed: IPX0;
- Safety degree when used in flammable anesthesia mixed with air or flammable narcotic with oxygen or oxidized nitrogen Category: Non-AP or APG equipment;
- By operating mode: continuous operation;
- Wheelchair rated voltage and frequency: DC 24V;
- Input power of wheelchair: internal power supply equipment;
- Whether the wheelchair has a protective effect on defibrillation effect: No;
- Whether the wheelchair has a signal output and input part: No;
- Permanent installation of equipment or non-permanent installation of equipment: mobile devices.

3.3 Electric Diagram



3.4 Product Software Version

Software version of Power Wheelchair N5909 is V1.0.

6.2 Operation

6.2.1 Preparation before operation

- Do not turn on the power switch when sit on the power wheelchair, and do turn off the power switch when get off from the wheelchair. Please observe whether the hand brake works or not.
- Please fold the pedal first then hold the armrest to sit on the wheelchair; Do not get off the wheelchair by stepping on the pedal. Otherwise the chair maybe turned over, which is dangerous.

6.2.2 Practice before operation

- Find a spacious place like square and have a assistant to help you practice until you have enough confidence to operate it.
- Be certain to shut down the power when you up and down the wheelchair, and set a speed you need through speed adjustment button.
- We recommend you set the lowest speed until you can operate the electric wheelchair skillfully. (Figure 7)
- To Practice the stop operation, forward and backward. Push the handle, the wheelchair move to anywhere you want. (Figure 8)
- Firstly, ensure that it is the lowest speed when practice forward operation. After Skilled, you can practice "S" shaped turn. After you are familiar with "S" shaped turn, to practice backward operation, and pay attention to the speed control setting. And the backward speed should lower than forward speed. (Figure 9)

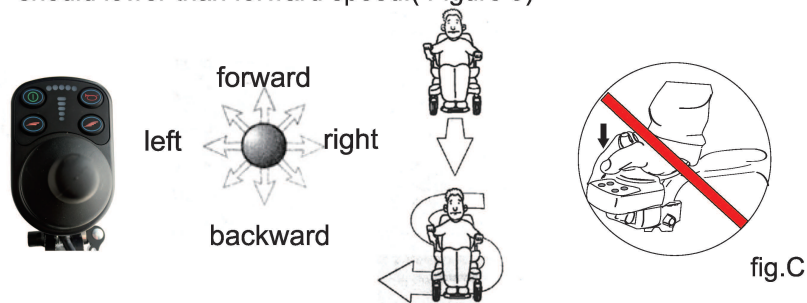

fig.C



Warning!
Do not press the joystick hard by hand when getting on/off the wheelchair to avoid any accident (Fig.C) .

6.2.3 Operation

Please do it according to precautions operation.

WARNING!
Do not use your wheelchair unless getting help from your assistant when the wheelchair is in manual mode. Otherwise it may result in personal injury.
Do not set your wheelchair in manual mode by yourself while you are seated in the wheelchair. Otherwise it may result in personal injury. In this case, please ask your assistant to help you.
Do not set your wheelchair in manual mode when it is on an incline. Otherwise, the wheelchair could be out of control to roll down by itself, and result in personal injury.

7. Fault diagnosis and troubleshooting

This product has an automatic fault warning function to give you very convenience. Once it malfunctions, the LEDs on the controller will flash with alarm sounded by the horn. You can find where a fault is according to information in Table 2.

If the fault still exists after checking out the fault based on that in table 2, Please consult your service agent immediately.

| | |
|-------------------------------|---|
| 2 Warning Tones+1 Fault Sound | Communication failure; To check the wiring. |
| 2 Warning Tones+2 Fault Sound | The right motor failure, or the relative plug poor connect |
| 2 Warning Tones+3 Fault Sound | The right brake failure, or the relative plug poor connect |
| 2 Warning Tones+4 Fault Sound | The left motor failure, or the relative plug poor connect |
| 2 Warning Tones+5 Fault Sound | The left brake failure, or the relative plug poor connect |
| 2 Warning Tones+6 Fault Sound | The controller at the overcurrent, or the motor short-circuited or overloaded |
| 2 Warning Tones+7 Fault Sound | The failure of controller lever, like the lever not reset or poor connect |
| 2 Warning Tones+8 Fault Sound | Failure of the controller |
| 2 Warning Tones+9 Fault Sound | Battery under voltage or fault |

8. Safety devices and accident treatment

8.1 Overload Protector: Refer to instruction manual 6.1.4

8.2 Safety belt: Refer to instruction manual 6.1.6

8.3 Please release the joystick whenever there is a wheelchair fault, the wheelchair will be stopped.

9.1 Maintenance

Like other motorized vehicle, your power wheelchair also requires routine maintenance. Some checks can be performed by yourself, others you can ask for assistance from your service agent. Preventive maintenance is very important. If you follow the maintenance and checks in this section, your wheelchair will give you years of trouble-free operation. If you have any doubt your wheelchair's care or operation, please contact your service agent or our after-sale service dept.

9.1.1 Humidity

Your wheelchair, like most electrical and mechanical equipment, is susceptible to external conditions. In any case, the wheelchair should be avoided damp environment. Direct or prolonged exposure to water or dampness could cause the wheelchair to malfunction electronically and mechanically. Water can cause electrical components and the chair's frame to corrode.

9.1.2 Temperature

- Some parts of your wheelchair are susceptible to temperature.
- In extremely cold temperature, the battery may be frozen. Special temperatures may cause a lot of factors to freeze, like charger type, usage, battery components (such as sealed lead-acid batteries or gel batteries);
- Temperature above 55° may cause your wheelchair's speed to reduce.

9.1.3 General Guidelines

- Avoid beating the controller, especially the joystick.
- Avoid prolonged exposure of your wheelchair to extreme conditions, such as hot, cold or moisture environment.
- Keep the controller clean.
- Check all electric connections, including the cable and connectors of the charger, and ensure that they are all tight and secure.
- If only red LEDs on the Battery Gauge lights, the batteries are nearly running out of charge. You should recharge the batteries as soon as possible. We recommend charging the battery for 8-12 hours
- Check the rear wheel inflatable situation, if the tire deformed serious when riding, it should be inflated;
- The frame surface has been sprayed with a clear sealant coating. You can apply a light coat of car wax to make the surface keep a high gloss.
- Check all cable connections. Make ensure they are fastened and are not corroded. The battery must be placed in the battery area, flat, the battery plug inward, relative display, refer to the correct connection on the main frame label;
- All wheel bearings are lubricated and sealed. Do not need to lubricate them.
- Check if there is loose phenomenon for wheel hub, drive device, and chair itself, if loose, please screw tightly in time.

9.1.4 Maintenance after use

- Turn off the power. (please disconnect all the connectors if not use for long time.)
- Inhibit children and unconscious person to use the wheelchair.
- Store the wheelchair in normal temperature to prevent reformation so that it keeps its performances for long period.
- Clean the wheelchair with a clear and soft cloth and dry it. Never use any chemicals to clean it. (to prevent deformation and discoloration)
- Remove the cloth cover of the seat rest to be washed if it is dirty, and then dry it for use.

9.1.5 Daily Checks

In order to keep the wheelchair in good condition, you should check before each use. And to maintain the weekly, monthly, semi-annual investigation, check the project see (Table III).

| Inspection Items | At any time | Weekly | Monthly | Six monthly |
|-----------------------|-------------|--------|---------|-------------|
| All parts | | | ○ | |
| Joystick function | ○ | | | |
| Brake System | ○ | | | |
| Connection | | ○ | | |
| Battery Condition | ○ | | | |
| Tire Condition | | | ○ | |
| Frame Condition | | | | ○ |
| Front Wheel Condition | | ○ | | |
| Pureness | ○ | | | |

9.1.6 Cleaning

Way of cleaning as below:

- Never wash your wheelchair with water or expose directly to water.
- Surface of wheelchair frame is coated with a protective coating. Therefore, it is very easy to wipe it clean with a damp cloth. Never use any chemicals to clean the vinylon seat and armrest, as they may cause the latter slip or chapped. You can use a damp cloth and neutral soapy water to clean them, and then dry thoroughly.

9.2 Repair

9.2.1 Users could repair or replace some spare parts like push handle, push handle cover which could be self-maintained or replaced by users under the instructions of after-sales service staff of our corporation or the dealers'.

9.2.2 Within the warranty, our corporation or the dealers will maintain or replace the faulted spare parts, like motor, battery, charger, controller, bearing, shaft sleeve, etc., due to material or manufacturing defects free of charge.

9.2.3 The spare parts like motor, controller, etc. which are confirmed by the after-sale staff or our corporation or our dealers' to be disassembled could be sent to our corporation or the dealers for maintenance.

9.2.4 Please contact your distributor or the after-sale service dept. of our corporation for any questions regarding the maintenance of power wheelchairs. Please refer to 12.1 Product Warranty.

10. Transportation and storage

10.1 Transportation

You can load and transport according to the shipping marks and graphics. For details, see the attachment.

10.2 Storage

Your wheelchair should be stored in a dry condition free from sources of extreme temperature and dampness. Remove the batteries from the wheelchair prior to storage. Otherwise, the frame may rust and the electronics may be damaged.

11. Opening and Checking

Open the packing box, and you can check whether there is anything missed or damaged.

Packing List

| No. | Name | Quantity | Remark |
|-----|--------------------|----------|---------------------------------|
| 1 | Power Wheelchair | 1pc | N5909 |
| 2 | Charger | 1pc | Model: HP0060W12/ 60HZ 24V2A |
| 3 | Instruction Manual | 1pc | |
| 4 | footrest | 2pc | |
| 5 | Controller | 1set | |

12. Quality Assurance

12.1 Warranty

12.2.1 Chair frame will have 5 years warranty service.

12.2.2 Within 1 year from the purchase date, for the following parts, we will supply free maintenance and replace service for original customer after the dealer check there are materials and production defect.

- Electrical control or lever system
- Motor/Drive System
- Bearing and shaft sleeve







12.2.3 Six-Months warranty for the batteries.

Please note the warranty service is provided by your dealer, and finally finished by our after-sales department and dealer together.

Out of warranty

- ABS plastic cover shell and rubber pad
- Tyre
- Interior decoration
- Damage by abuse, wrong operation, accidents and negligence
- Business use or other abnormal use

The name and symbols of the signs

| No. | Sign | meaning |
|-----|---|--|
| 1 |  | fragile objects inside the packaging, please handle with care |
| 2 |  | keep the packaging up during transportation |
| 3 |  | Keep the packaging avoid from rain |
| 4 |  | The max. layers of stacking same packaging is 2. |
| 5 |  | Hand hooks are forbidden when carry or transport the packagings |
| 6 |  | Application type B |
| 7 | IPX1 | Plummeted Droplets (condensed water for example) do not damage the electrical appliance. |
| 8 |  | Attentions |